

Team Oracle Challenger 2



Spannweite:	780mm
Länge:	780mm
Abfluggewicht:	160-220g

Dieser Plan ist zur nichtkommerziellen Verwendung freigegeben. Als Gegenleistung bitte ich (sofern wirklich jemand das Teil nachbaut :-)) um ein Bild des fertigen Modells an meine eMail-Adresse dj@danieljust.de

WWW.DANIELJUST.DE

Stand: 27.02.2006

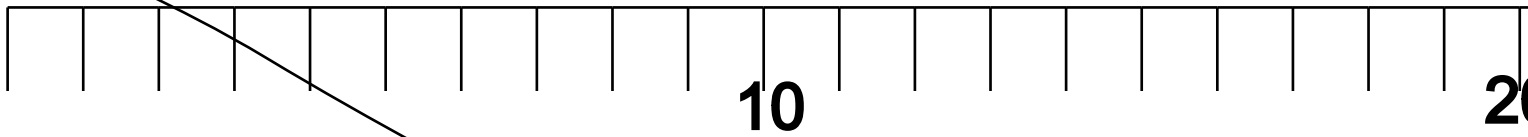
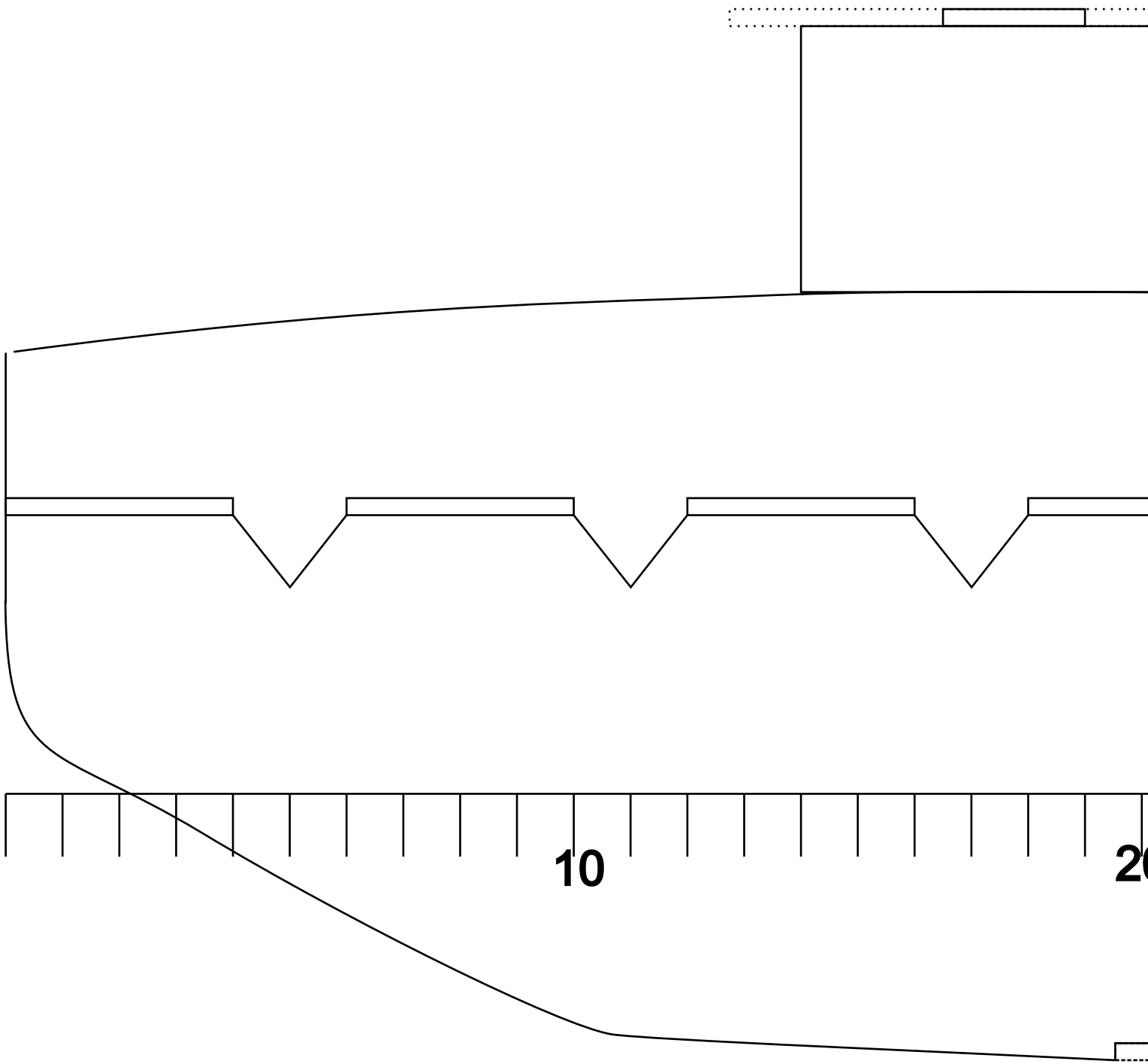
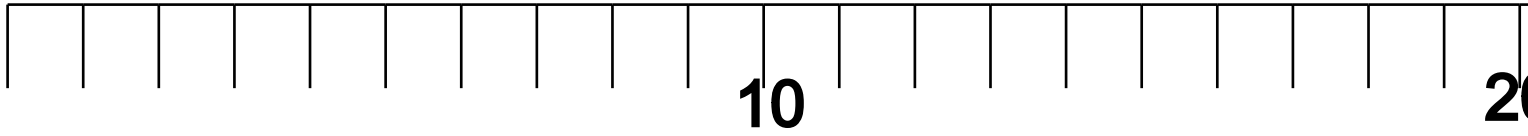

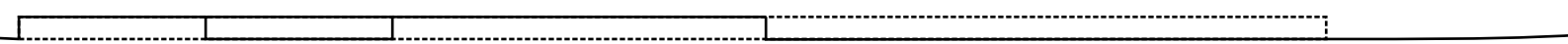
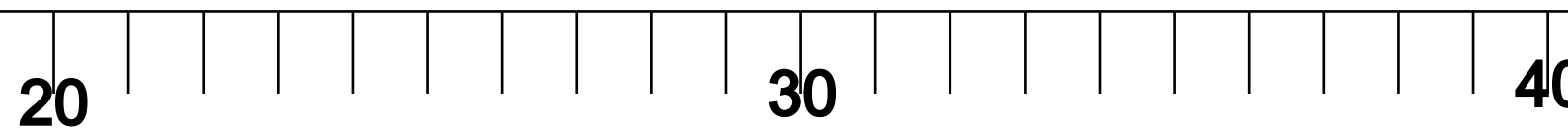
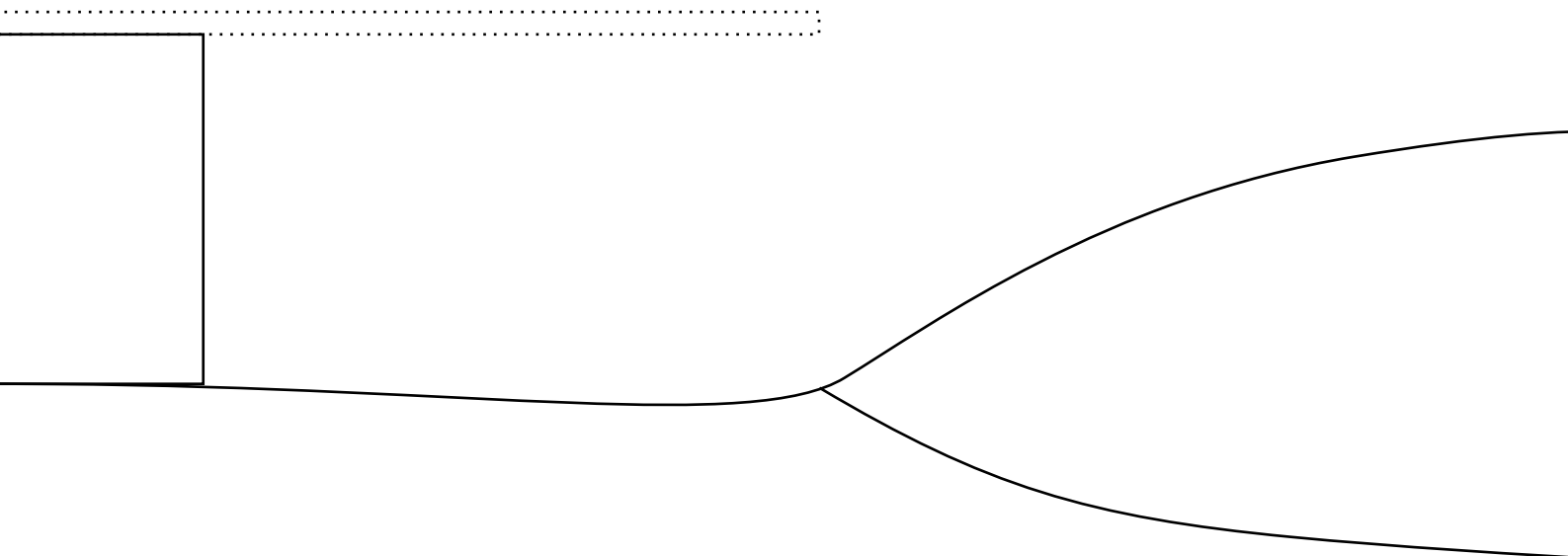
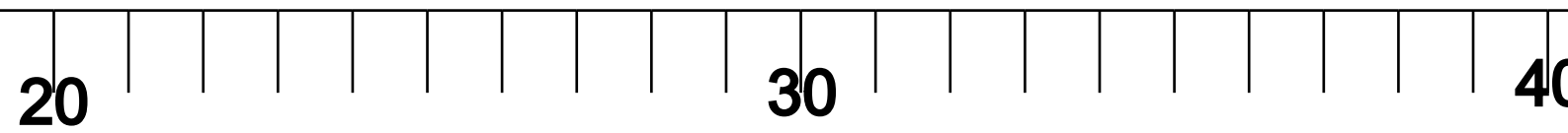

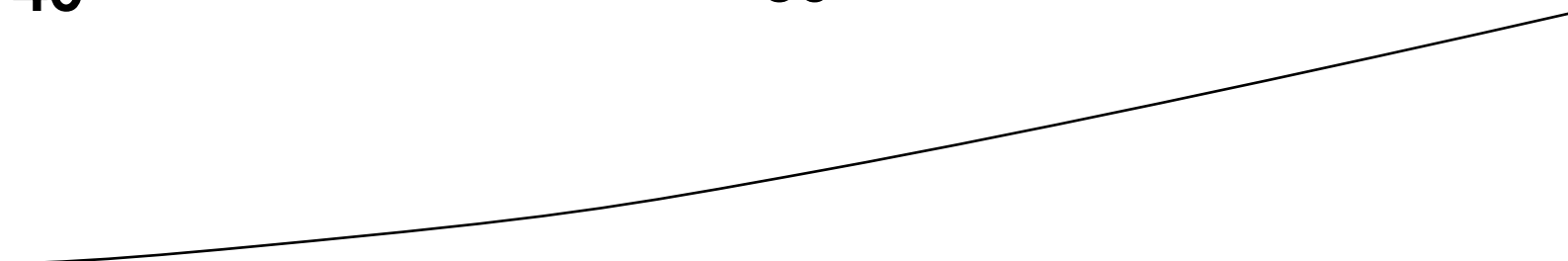
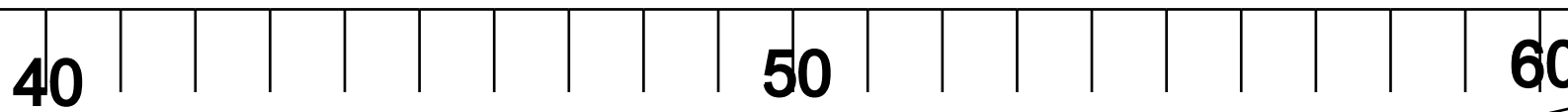
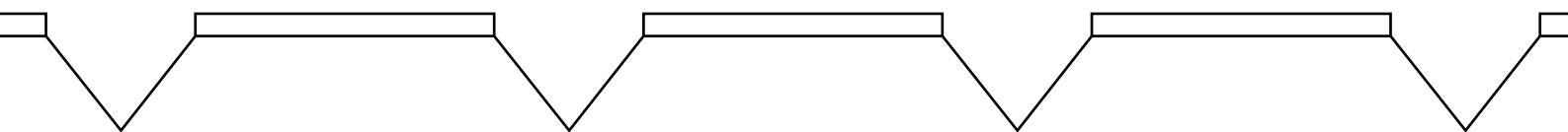
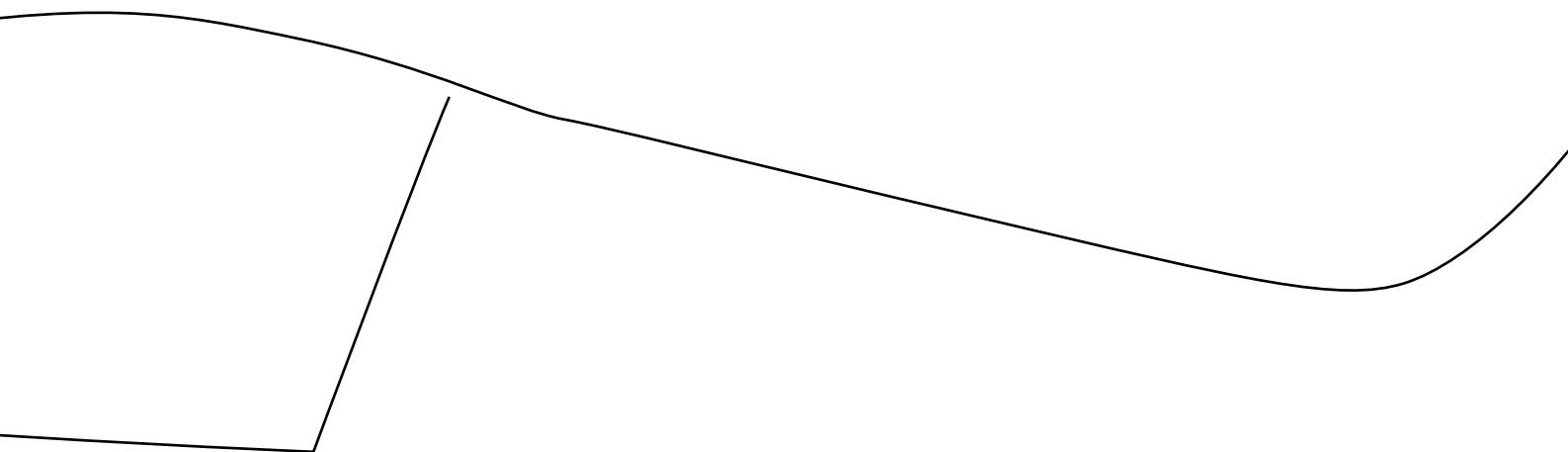
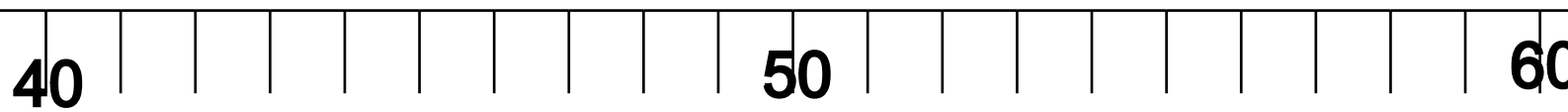

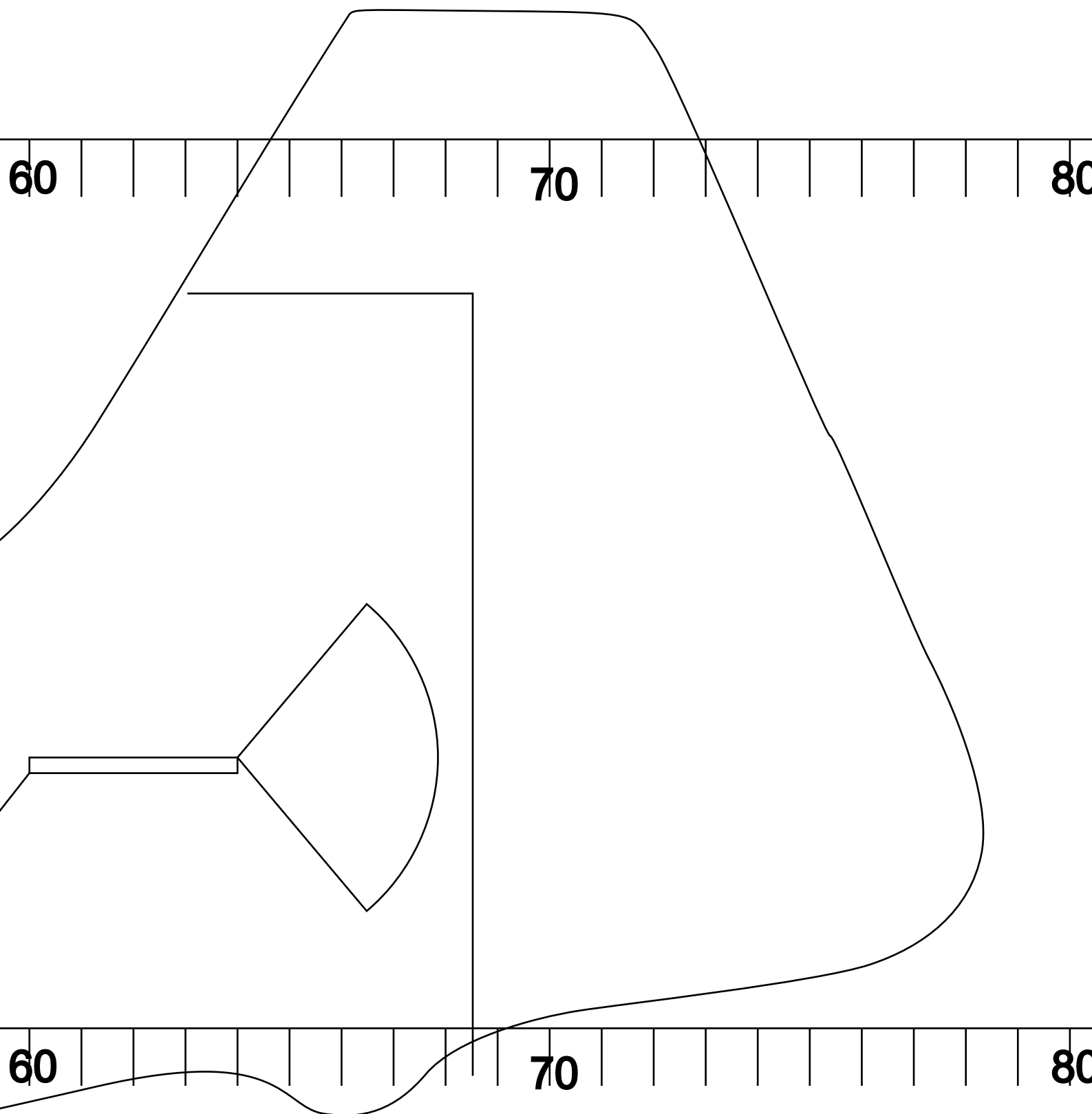

10

10

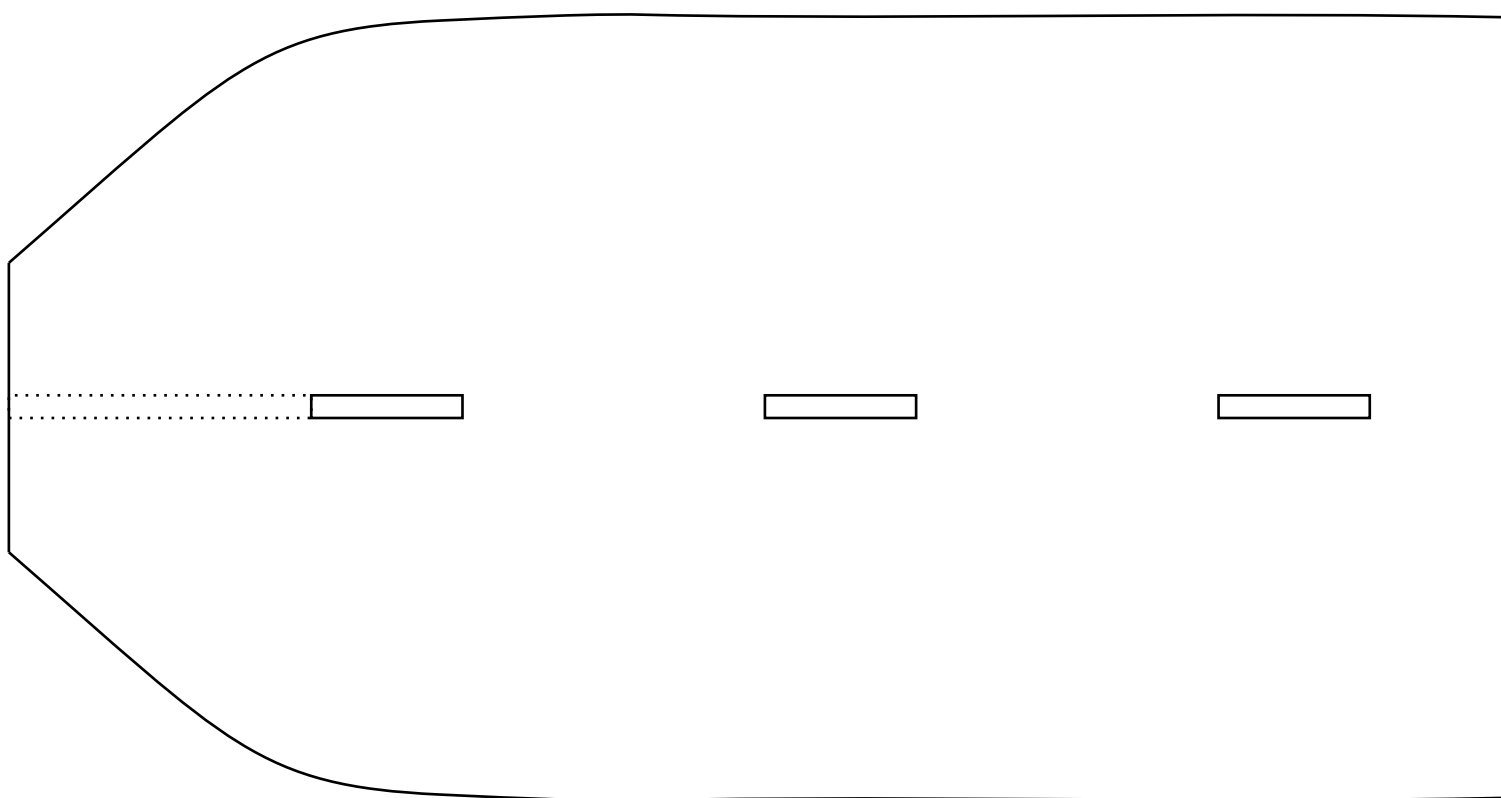
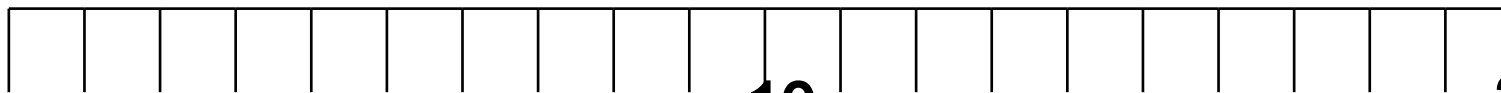

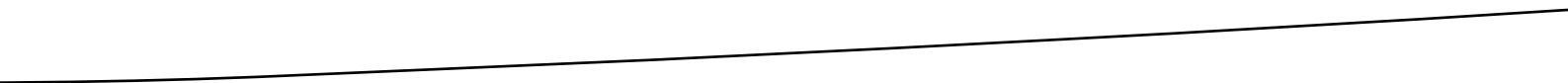
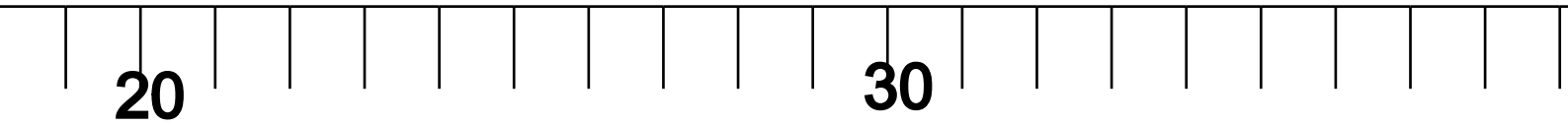
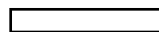
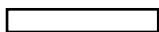
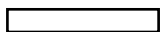
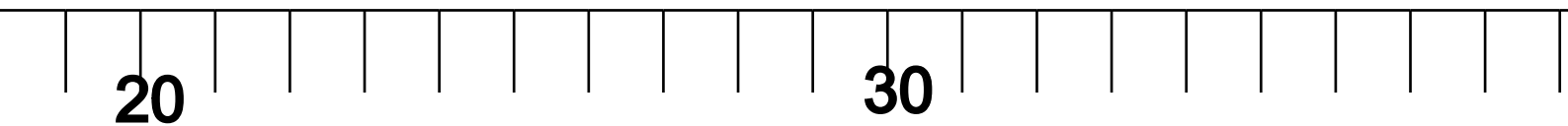

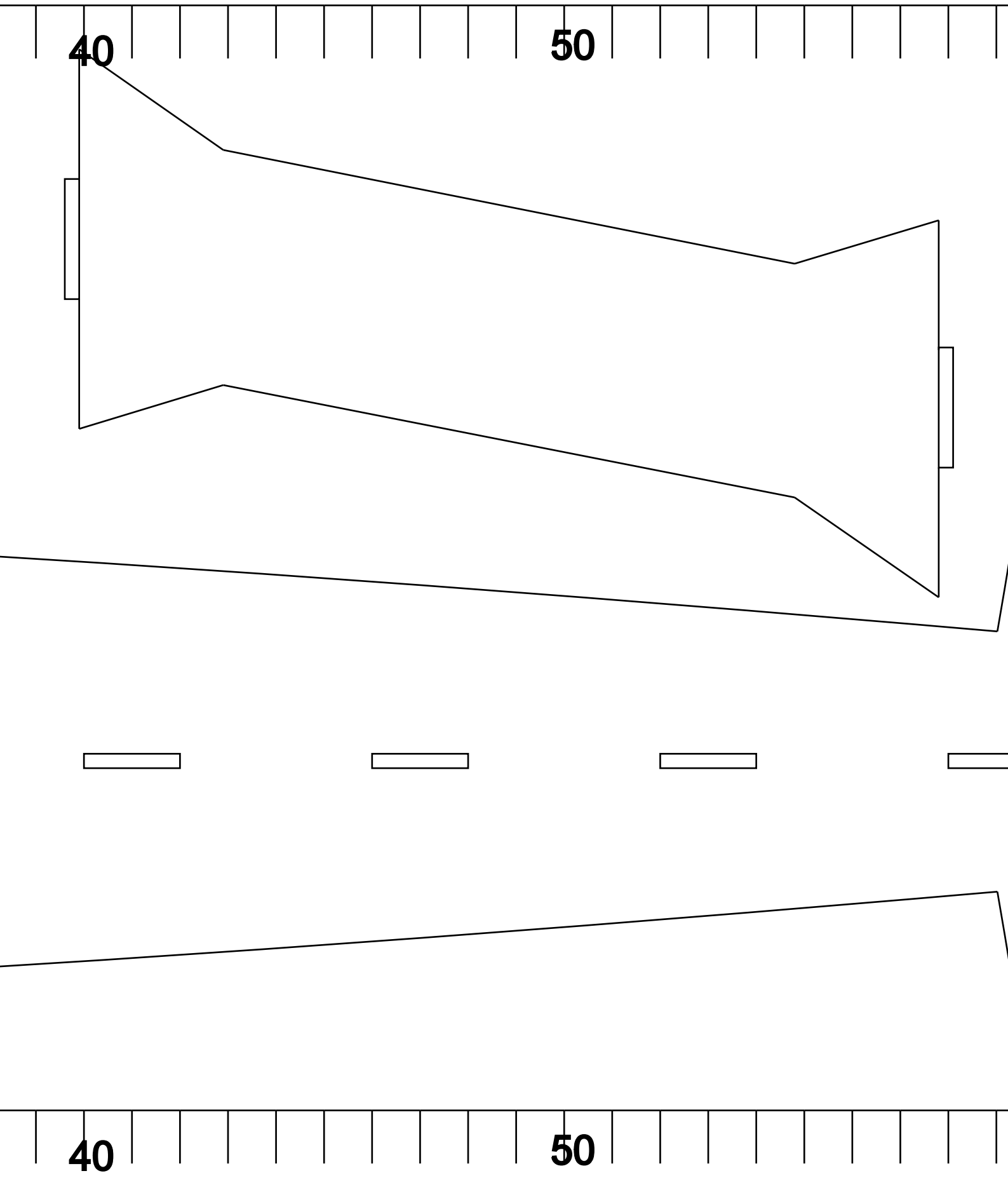

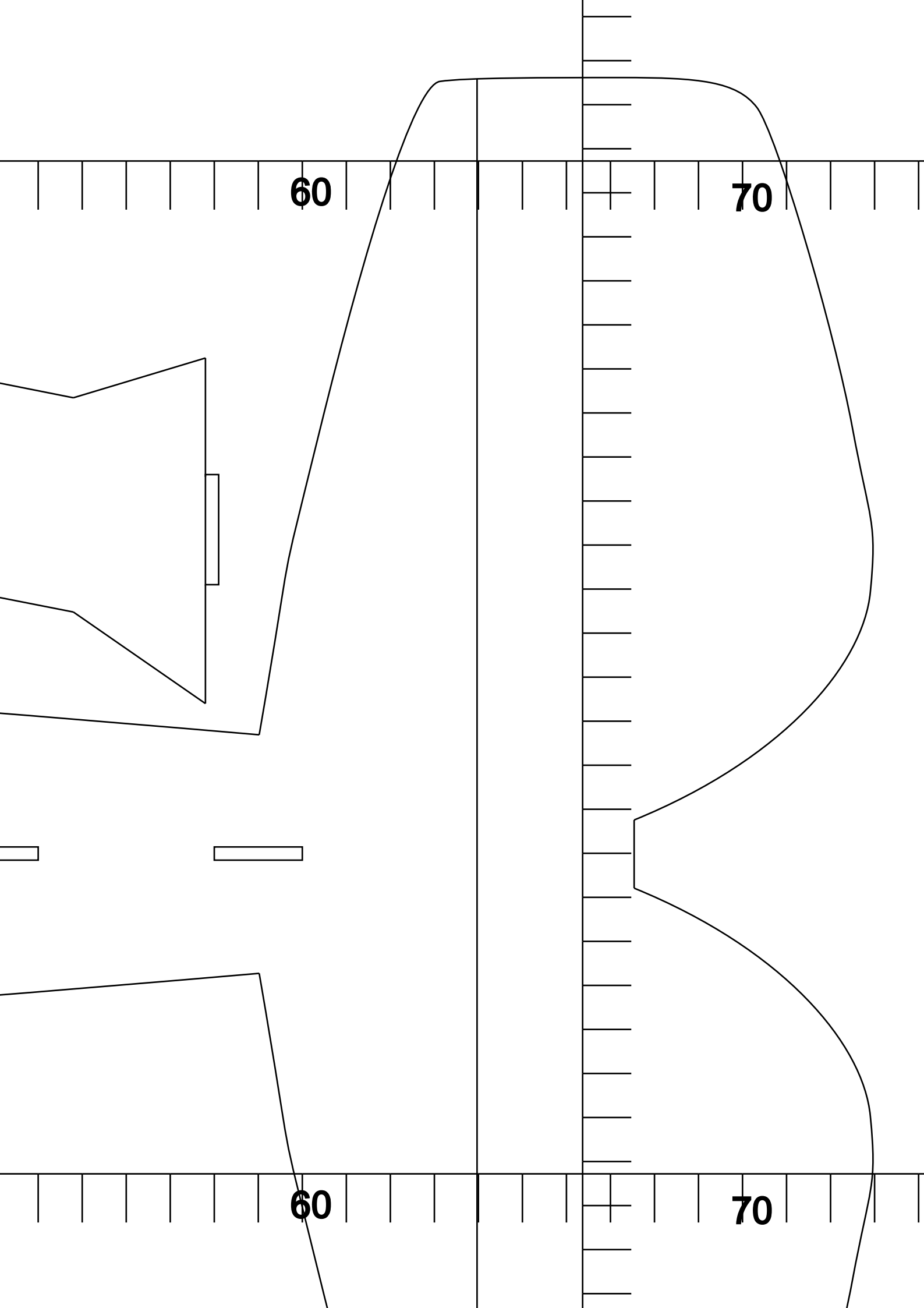

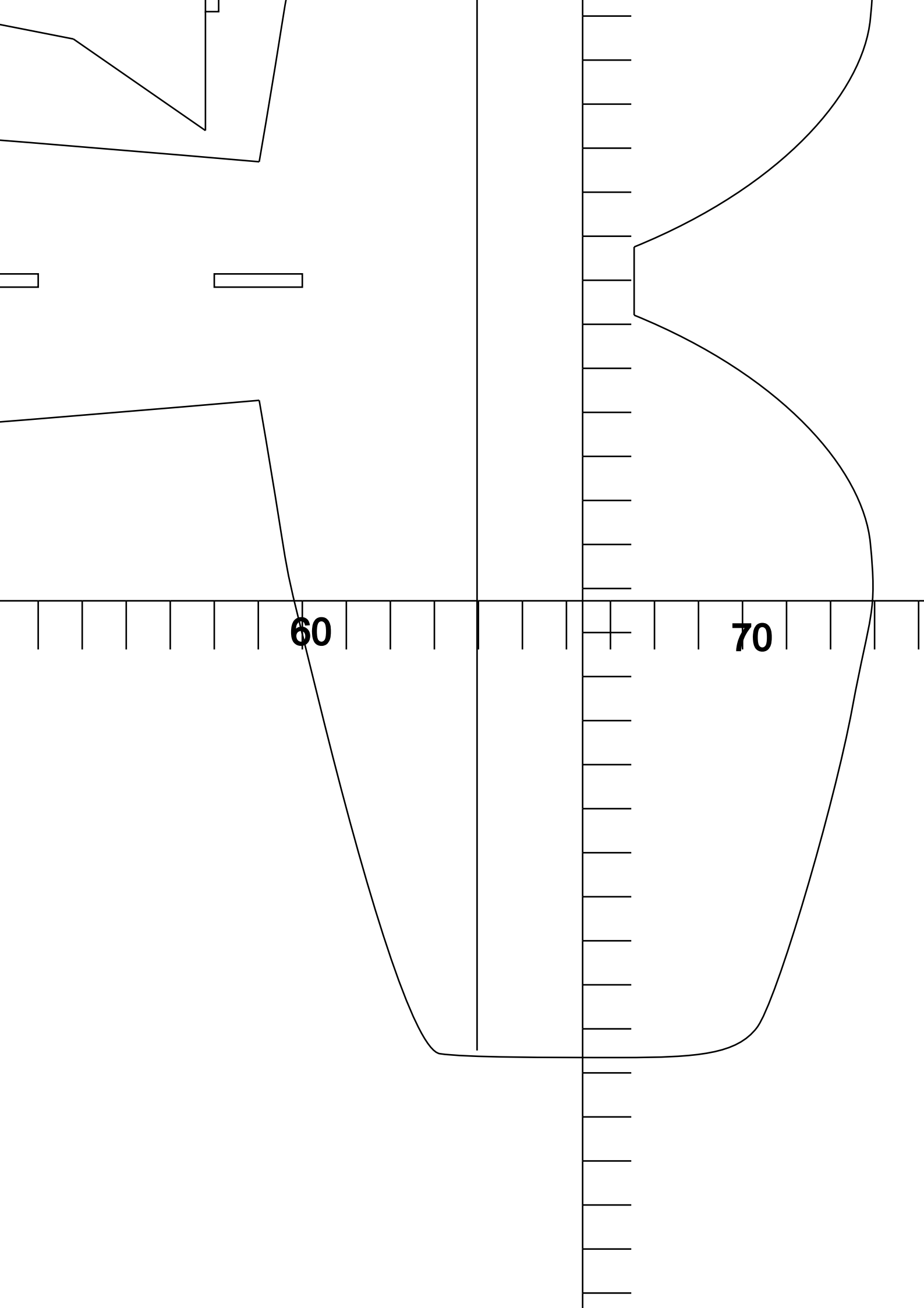

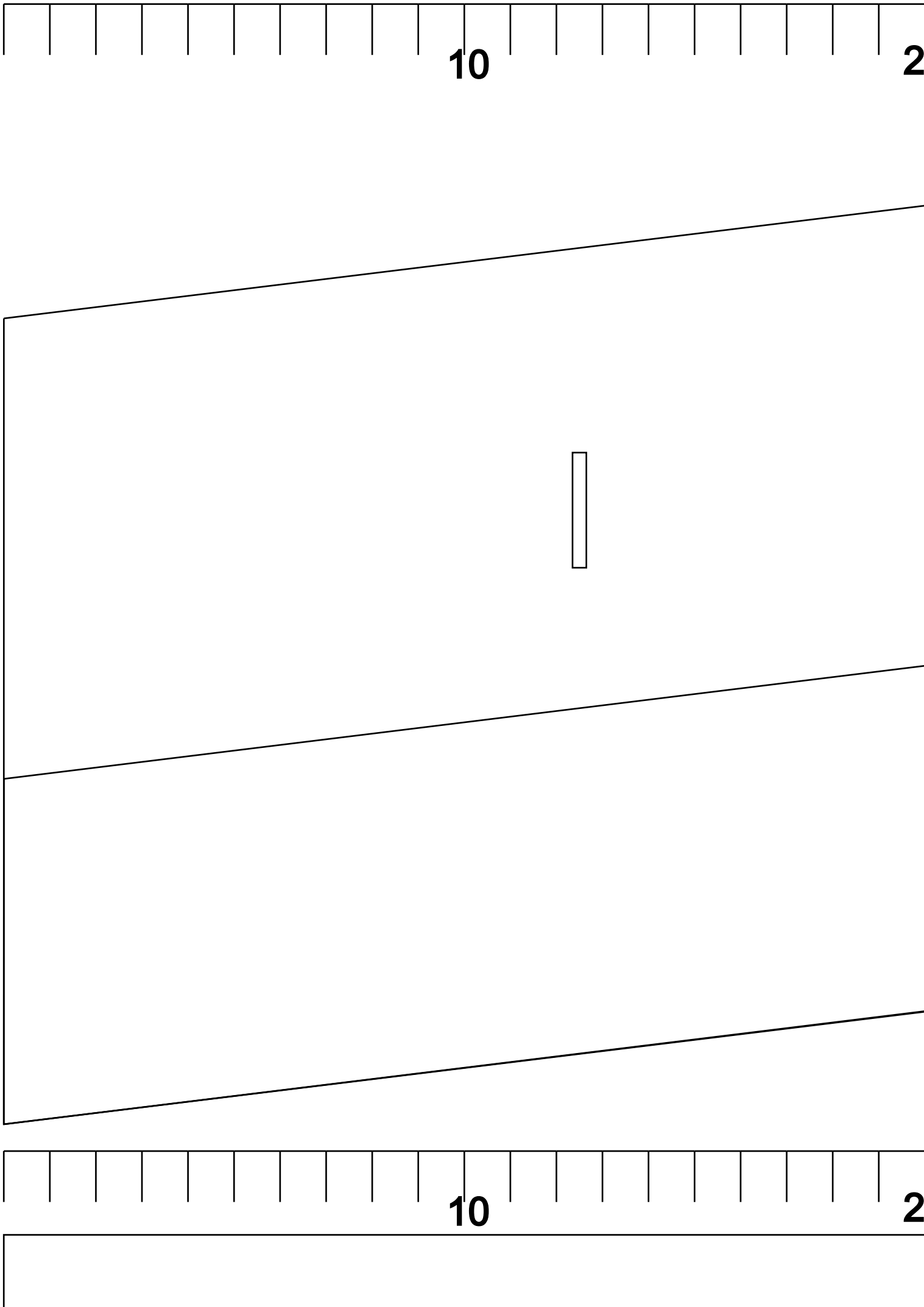

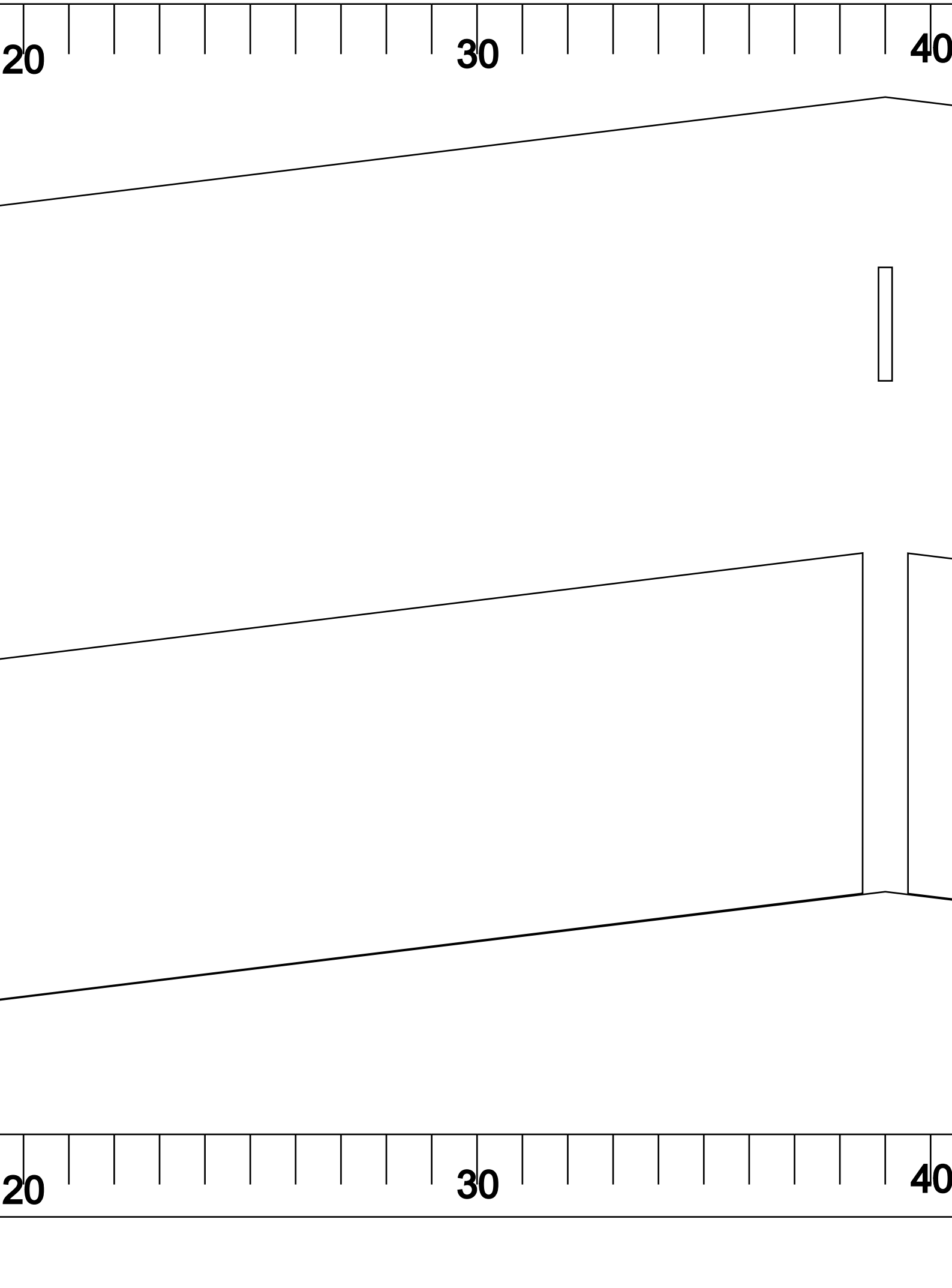

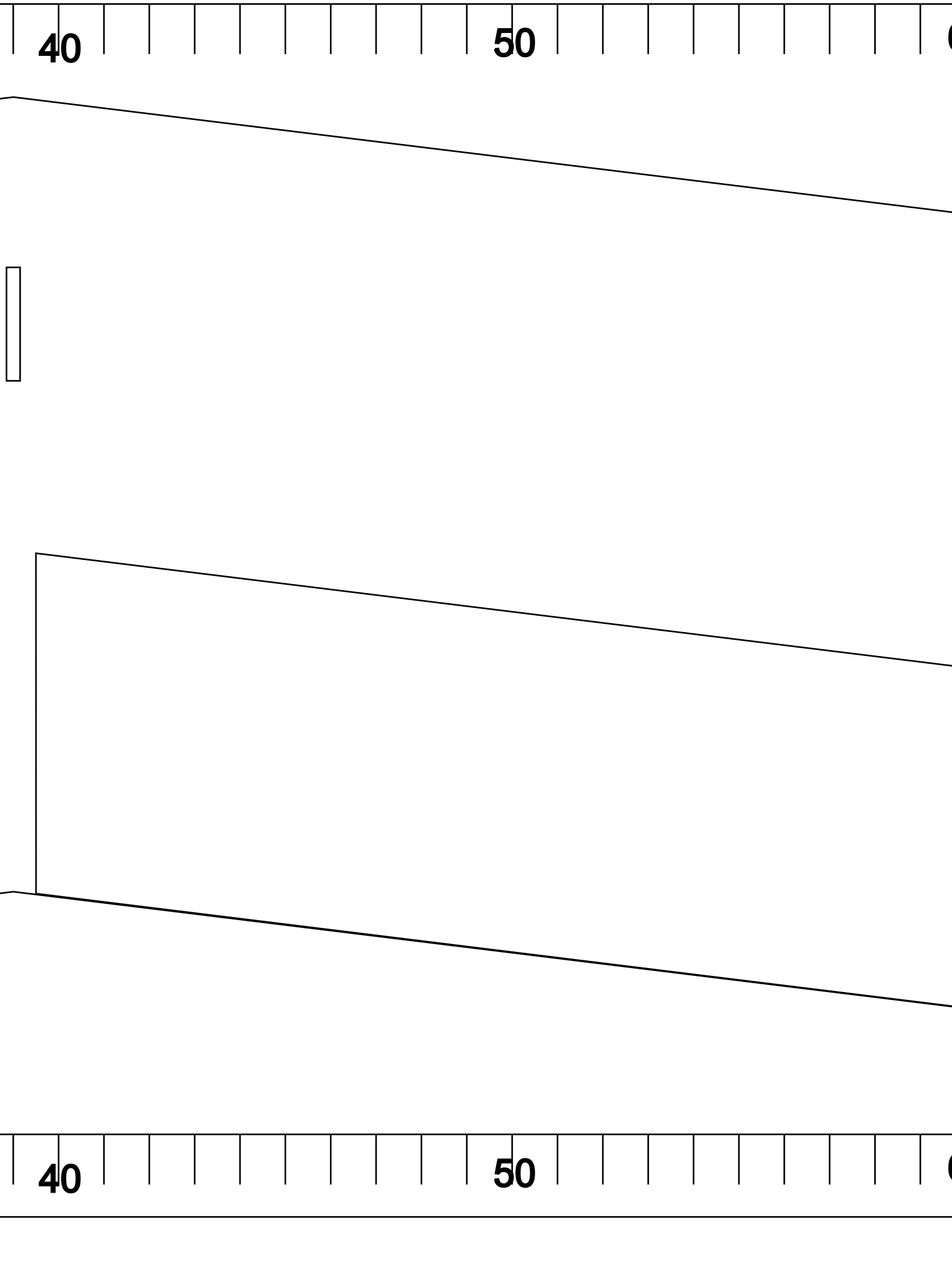

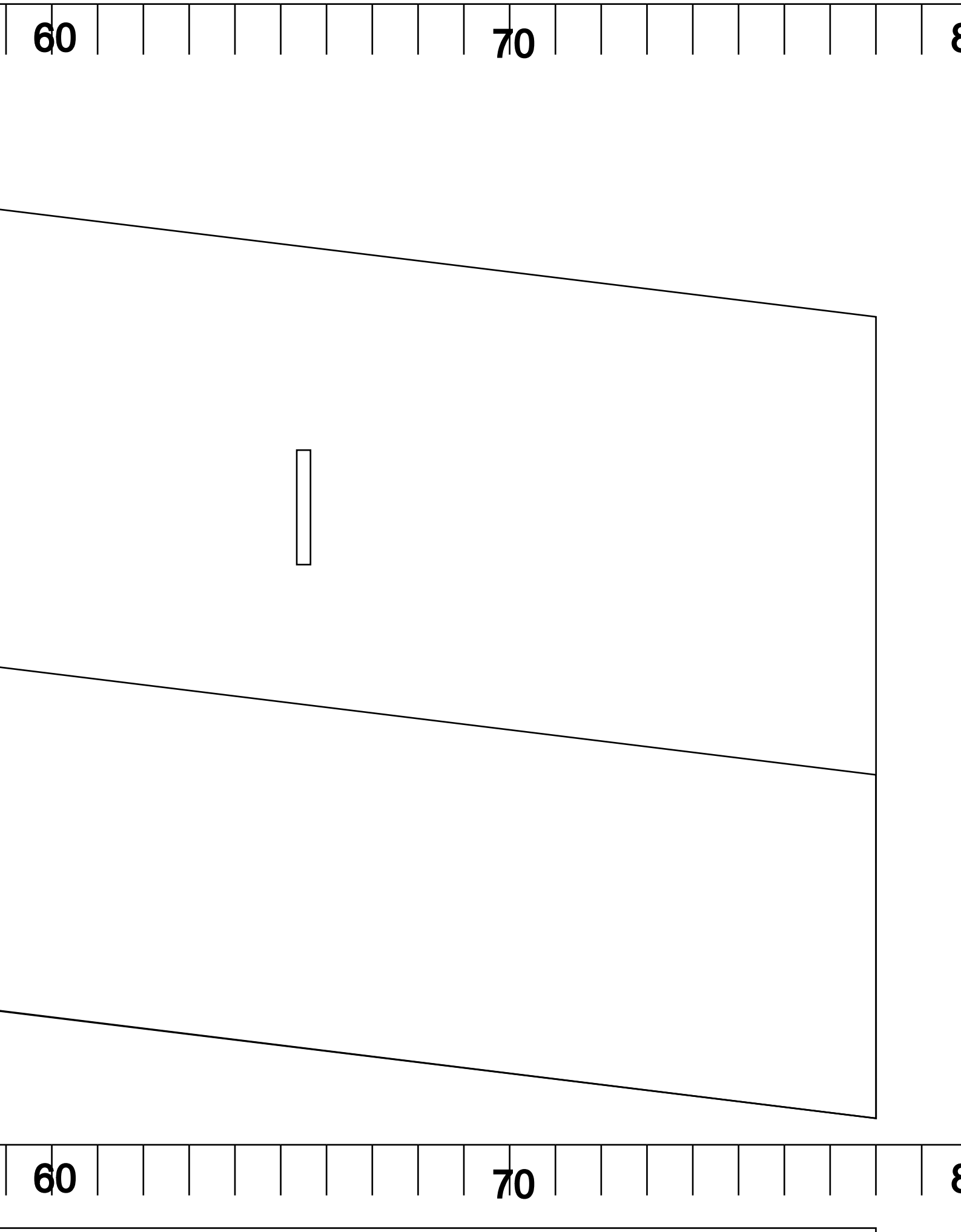

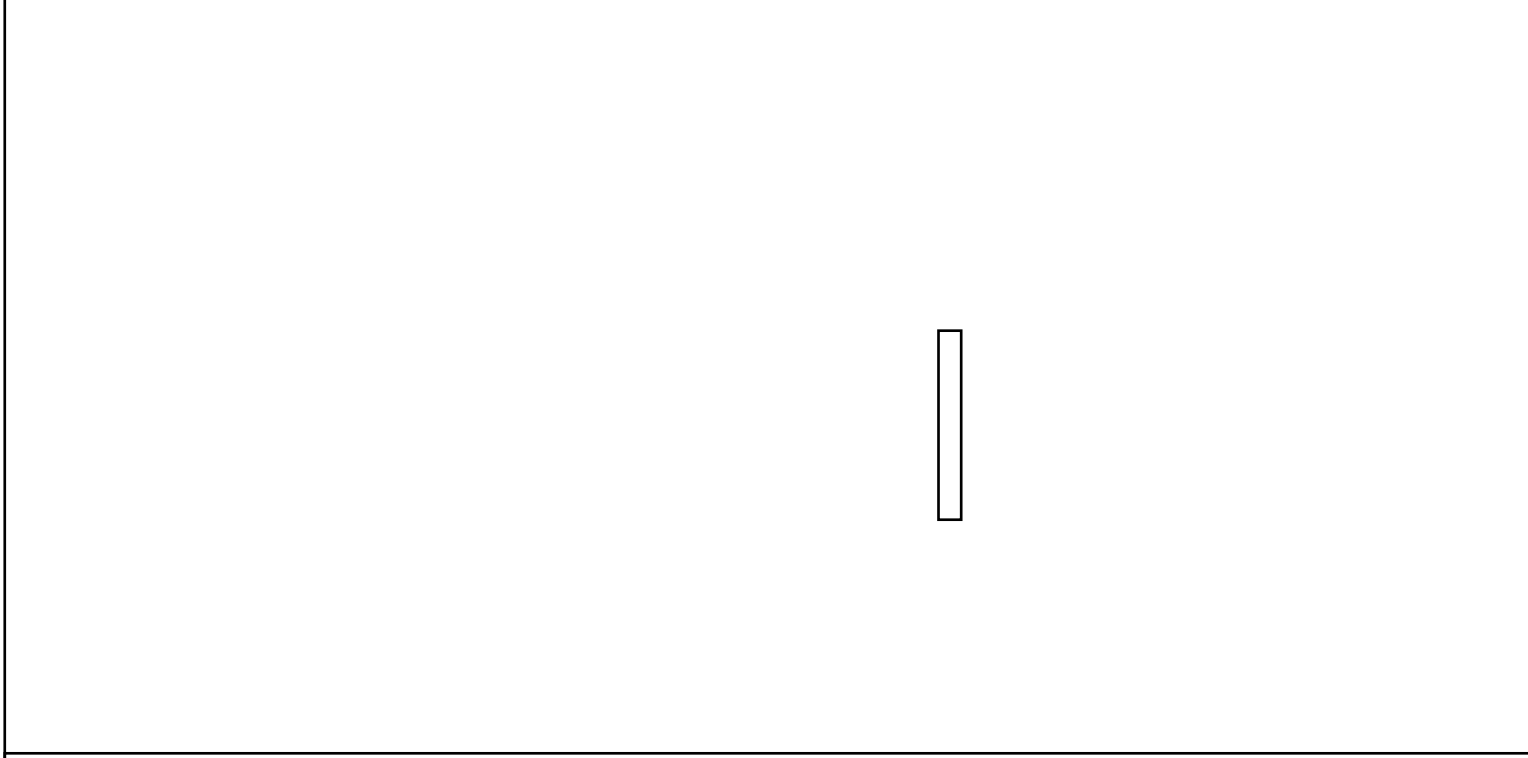
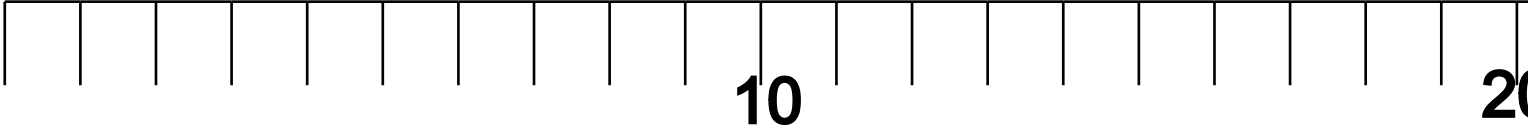
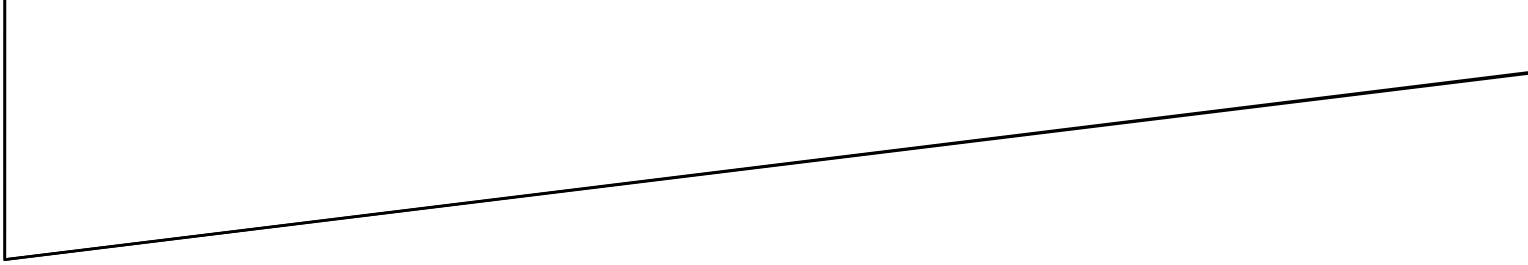

WWW.DANIELJUS

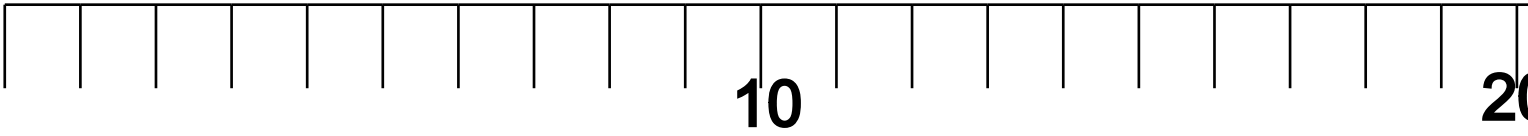

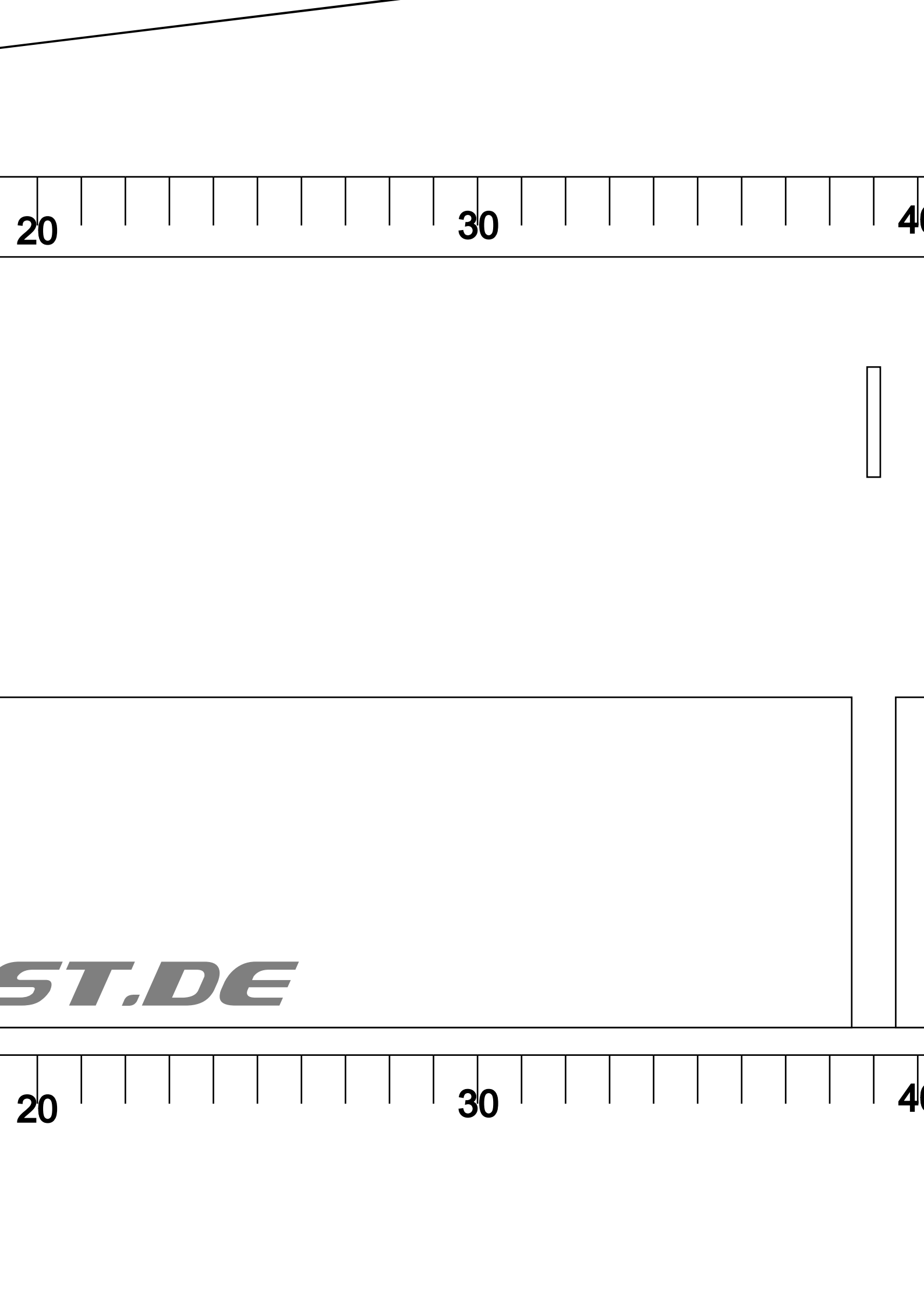

20

30

40

ST.DE

20

30

40

